

# Hoses and Connectors

MH, MM, PS, MP, TH and HC Series

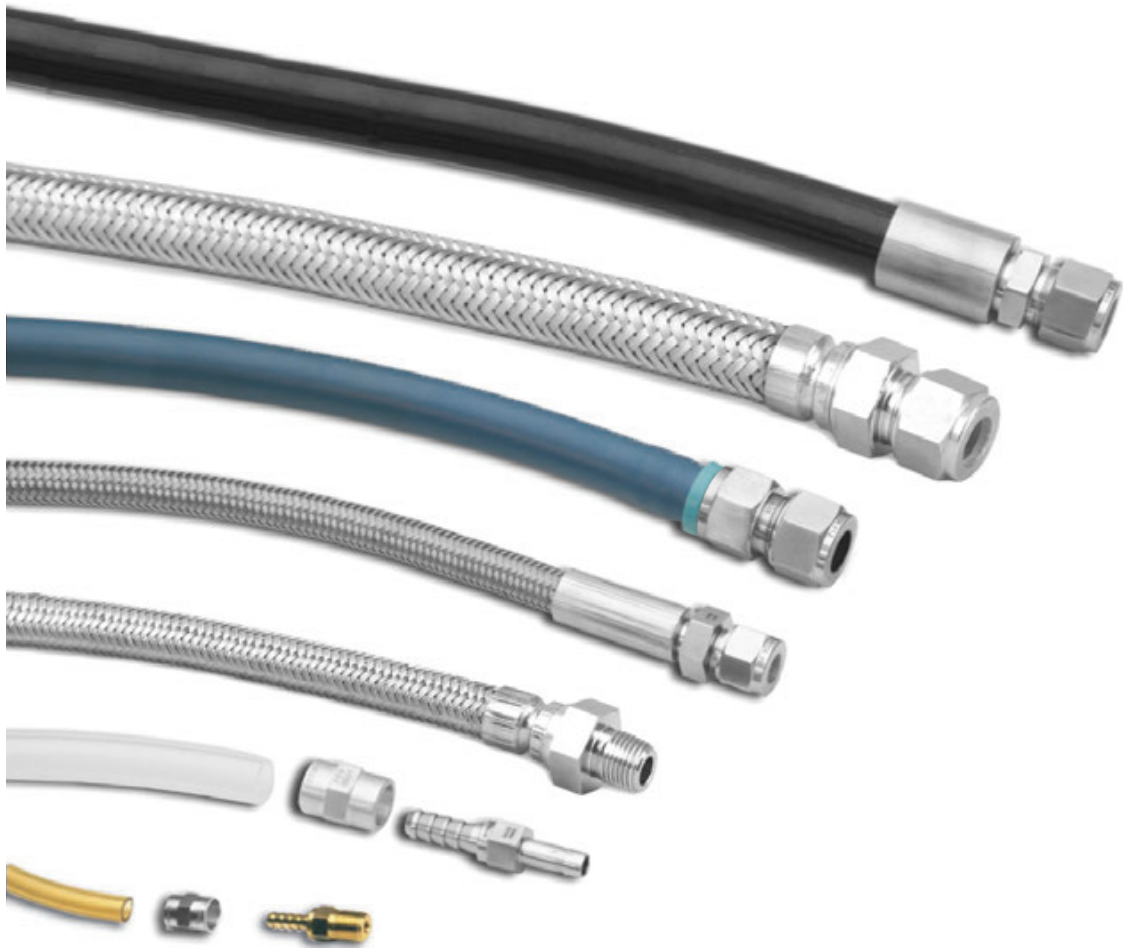

# Contents

## Metal Flexible Hoses

MH, MM Series



D-05

## PTFE-lined, Stainless Steel Braided Hoses

PS Series



D-11

## Multipurpose Push-on Hoses

MP Series



D-14

## Thermoplastic Hoses

TH Series



D-18

## Hose Connectors and Sleeves

HC Series



D-20

## Terms and Definitions

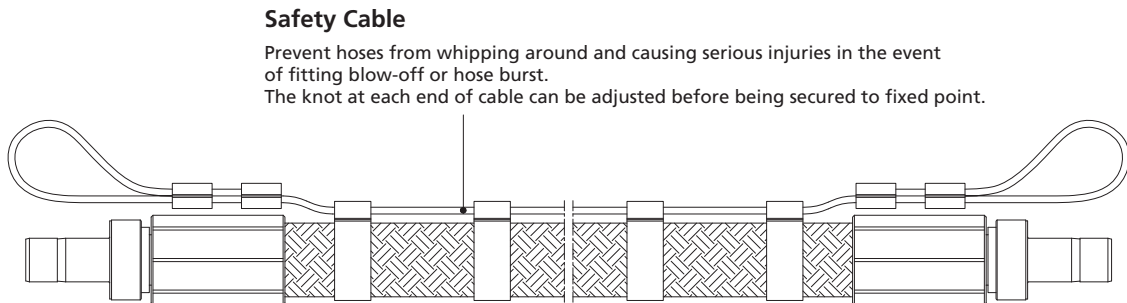
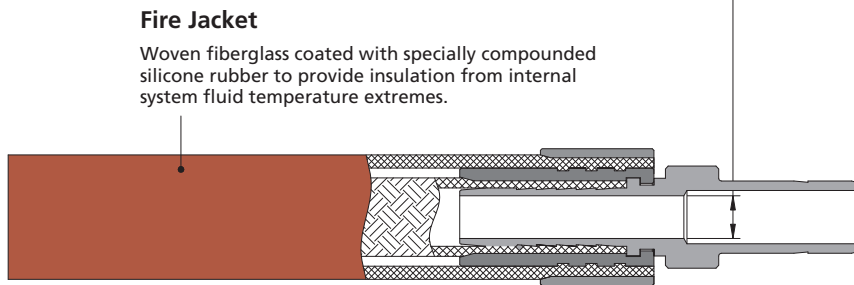
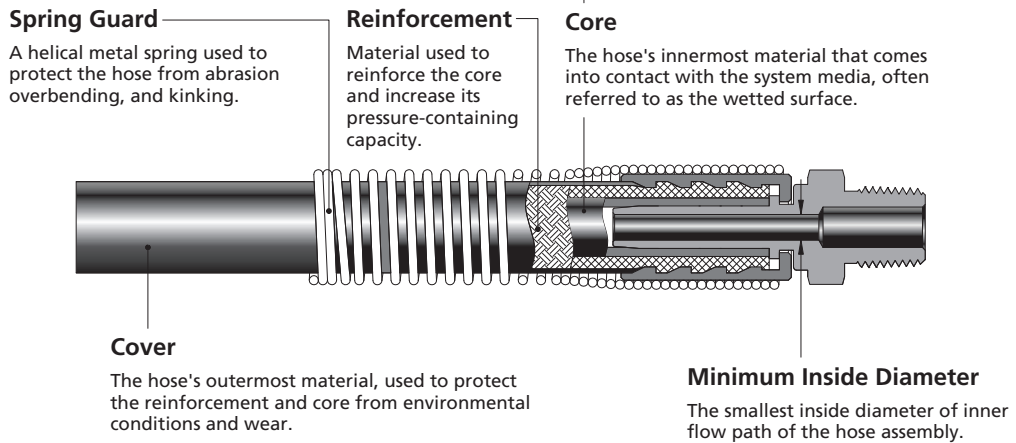
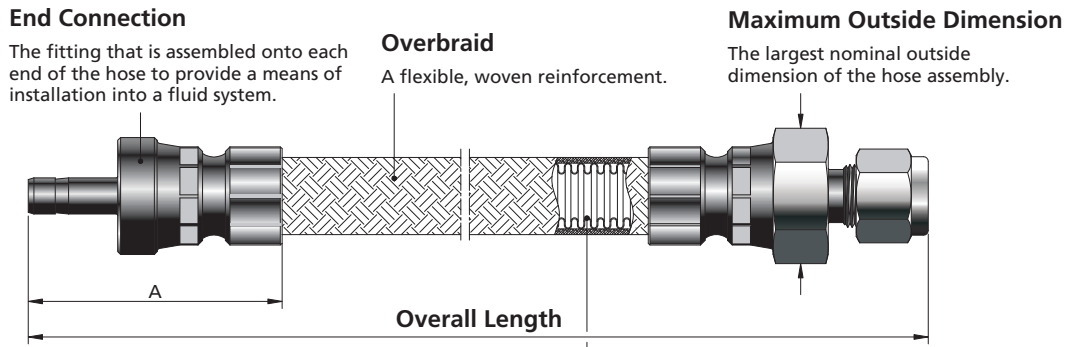

# Metal Flexible Hoses

## MH, MM Series

### Features

- ⦿ Core tube and fitting material: 316 stainless steel
- ⦿ Overbraid material: 304 stainless steel (316 SS available)
- ⦿ Vacuum and positive pressure applications
- ⦿ Working pressure up to: 3100 psig (213 bar)
- ⦿ Nominal hose size: 1/4" to 2"
- ⦿ Working temperature: -325°F to 800°F (-200°C to 426°C)
- ⦿ End connections:
  - 1/4 to 2 thread
  - 1/4" to 2" and 6 mm to 50 mm tube fitting
- ⦿ Welded fitting-to-hose construction to ensure reliable seal
- ⦿ Standard and custom length available

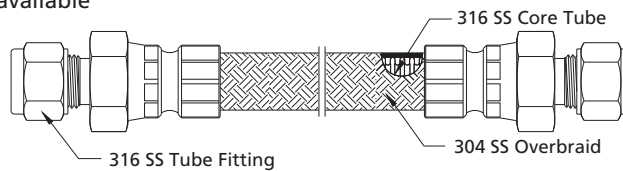

### Hose Technical Data (MH Series)

Nominal Hose Size	Inside Diameter in. (mm)	Min. Bend Radius		Temperature Range °F (°C)	Working Pressure at 70°F (20°C) psig (bar)	Min. Burst Pressure at 70°F (20°C) psig (bar)	Hose Series
		Static in. (mm)	Dynamic in. (mm)				
1/4 (6.4)	0.28 (7.1)	2.25 (57.2)	10.0 (254)	-325 to 800 (-200 to 426)	3100 (213)	12400 (854)	MH4
3/8 (9.7)	0.42 (10.6)	3.00 (76.2)	12.0 (305)		2000 (137)	8000 (551)	MH6
1/2 (12.7)	0.53 (13.5)	4.50 (114)	16.0 (406)		1800 (124)	7200 (496)	MH8
3/4 (19.0)	0.80 (20.3)	6.00 (152)	17.0 (432)		1500 (103)	6000 (413)	MH12
1 (25.4)	1.03 (26.0)	6.75 (171)	20.0 (508)		1200 (82.6)	4800 (330)	MH16
1 1/4 (31.8)	1.30 (33.0)	8.86 (225)	23.0 (584)		950 (65.4)	3800 (261)	MH20
1 1/2 (38.1)	1.53 (38.9)	11.0 (280)	26.0 (660)		900 (62.0)	3600 (248)	MH24
2 (50.8)	2.05 (52.1)	13.8 (350)	32.0 (813)		500 (34.4)	2000 (137)	MH32

### Hose Technical Data (MM Series)

Nominal Hose Size	Inside Diameter in. (mm)	Min. Bend Radius				Temperature Range °F (°C)	Working Pressure at 70°F (20°C) psig (bar)	Min. Burst Pressure at 70°F (20°C) psig (bar)	Hose Series
		Helical Convuluted Core		Annular Convuluted Core					
		Static in. (mm)	Dynamic in. (mm)	Static in. (mm)	Dynamic in. (mm)				
1/4 (6.4)	0.25 (6.4)	1.38 (35)	8.66 (220)	0.79 (20)	4.33 (110)	-325 to 800 (-200 to 426)	1600 (110)	6400 (440)	MM4
3/8 (9.7)	0.38 (9.5)	2.36 (60)	10.40 (264)	0.98 (25)	5.91 (150)		1470 (101)	6000 (413)	MM6
1/2 (12.7)	0.50 (12.7)	2.95 (75)	11.89 (302)	1.18 (30)	4.88 (124)		1110 (76.4)	4500 (310)	MM8
3/4 (19.0)	0.75 (19.0)	3.54 (90)	13.58 (345)	1.50 (38)	6.65 (169)		860 (59.2)	3500 (241)	MM12
1 (25.4)	1.00 (25.4)	4.13 (105)	15.00 (381)	1.77 (45)	7.68 (195)		680 (46.8)	2680 (184)	MM16
1 1/4 (31.8)	1.25 (31.8)	4.72 (120)	16.22 (412)	/			680 (46.8)	2600 (179)	MM20
1 1/2 (38.1)	1.50 (38.1)	5.51 (140)	16.89 (429)				520 (35.8)	2200 (151)	MM24
2 (50.8)	2.00 (50.8)	6.30 (160)	18.43 (468)				450 (31.0)	1800 (124)	MM32

## Testing

Every FITOK metal flexible hose assembly is factory tested with helium to a maximum leak rate of  $1 \times 10^{-5}$  std cm<sup>3</sup>/s.

## Cleaning and Packaging

FITOK metal flexible hose components are cleaned in accordance with FITOK *Standard Cleaning and Packaging Process (FC-01)* for general industrial procedures.

Shorter hoses are packed in cartons with suitable protective material, longer hoses are coiled, bagged and boxed or crated.

## Pressure vs. Temperature

### MH series

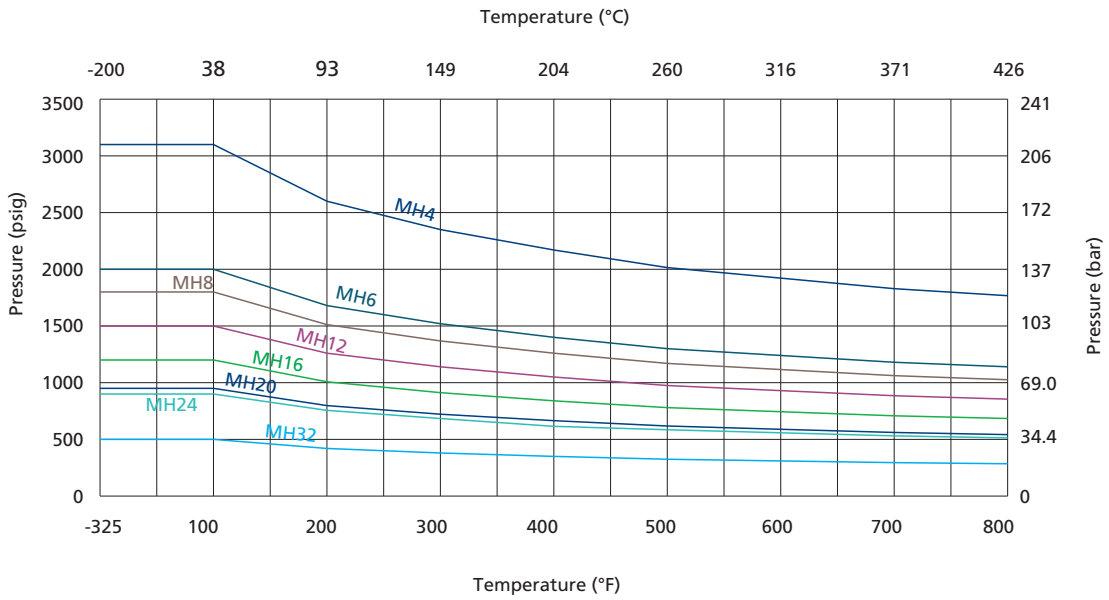

### MM series

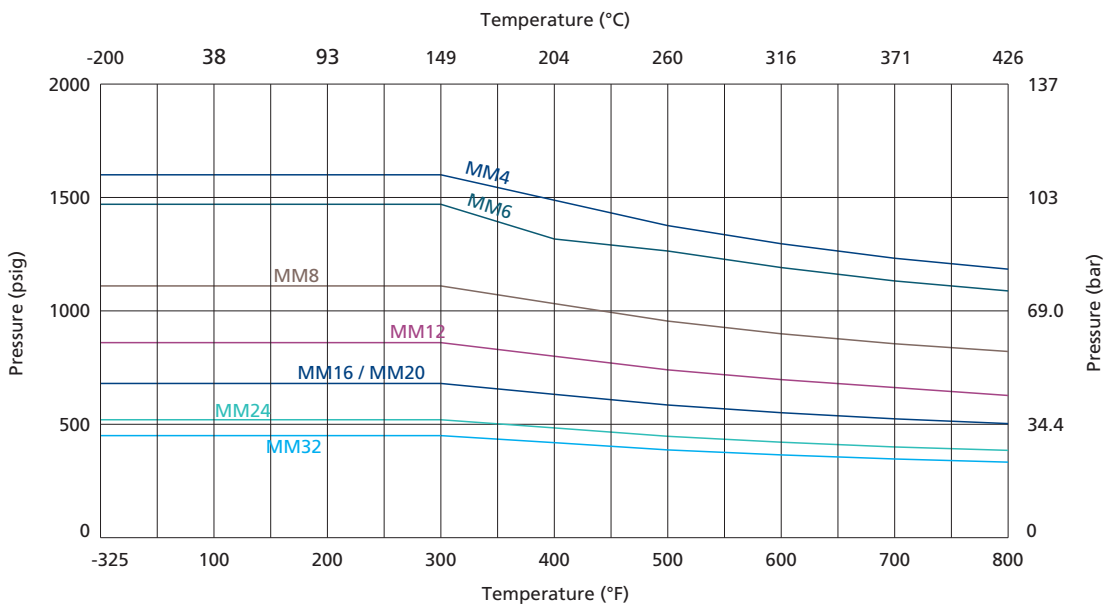

The peak value of pressure surge, shock or pulsations in the system should not exceed 50% of the rated working pressure of the hose.

## Standard Assemblies

### Tube Fitting to Male NPT End

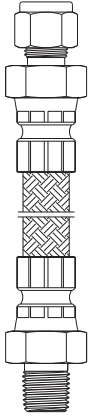

Nominal Hose Size	Tube Fitting Size	NPT Size	Hose Series	Overall Length	Ordering Number	Minimum Inside Diameter	Maximum Outside Dimension
	in.	in.		in. (mm)		in. (mm)	in. (mm)
1/4	1/4	1/4	MH4	12 (305)	SS-MH4-FL4-NS4-F12	0.19 (4.8)	0.94 (23.8)
			MM4	36 (914)	SS-MM4-FL4-NS4-F36	0.19 (4.8)	0.87 (22.0)
3/8	3/8	3/8	MH6	18 (457)	SS-MH6-FL6-NS6-F18	0.28 (7.1)	1.09 (27.7)
			MM6	36 (914)	SS-MM6-FL6-NS6-F36	0.28 (7.1)	1.01 (25.7)
1/2	1/2	1/2	MH8	18 (457)	SS-MH8-FL8-NS8-F18	0.41 (10.4)	1.23 (31.3)
			MM8	48 (1220)	SS-MM8-FL8-NS8-F48	0.41 (10.4)	1.23 (31.3)
3/4	3/4	3/4	MH12	18 (457)	SS-MH12-FL12-NS12-F18	0.66 (16.0)	1.74 (44.2)
			MM12	48 (1220)	SS-MM12-FL12-NS12-F48	0.66 (16.0)	1.59 (40.5)
1	1	1	MH16	24 (610)	SS-MH16-FL16-NS16-F24	0.88 (22.4)	1.82 (46.3)

### Tube Fitting End

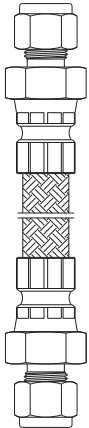

Nominal Hose Size	Tube Fitting Size	Hose Series	Overall Length	Ordering Number	Minimum Inside Diameter	Maximum Outside Dimension
	in.		in. (mm)		in. (mm)	in. (mm)
1/4	1/4	MH4	12 (305)	SS-MH4-FL4-F12	0.19 (4.8)	0.94 (23.8)
		MM4	36 (914)	SS-MM4-FL4-F36	0.19 (4.8)	0.87 (22.0)
3/8	3/8	MH6	18 (457)	SS-MH6-FL6-F18	0.28 (7.1)	1.09 (27.7)
		MM6	36 (914)	SS-MM6-FL6-F36	0.28 (7.1)	1.01 (25.7)
1/2	1/2	MH8	18 (457)	SS-MH8-FL8-F18	0.41 (10.4)	1.23 (31.3)
		MM8	48 (1220)	SS-MM8-FL8-F48	0.41 (10.4)	1.23 (31.3)
3/4	3/4	MH12	18 (457)	SS-MH12-FL12-F18	0.66 (16.0)	1.74 (44.2)
		MM12	48 (1220)	SS-MM12-FL12-F48	0.66 (16.0)	1.59 (40.5)
1	1	MH16	24 (610)	SS-MH16-FL16-F24	0.88 (22.4)	1.82 (46.3)

### Tube Adapter End

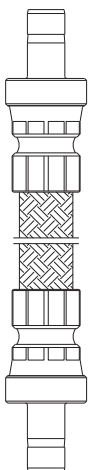

Nominal Hose Size	Tube Adapter Size	Hose Series	Overall Length	Ordering Number	Minimum Inside Diameter	Maximum Outside Dimension
	in.		in. (mm)		in. (mm)	in. (mm)
1/4	1/4	MH4	12 (305)	SS-MH4-FT4-F12	0.16 (4.1)	0.81 (20.6)
		MM4	36 (914)	SS-MM4-FT4-F36	0.16 (4.1)	0.76 (19.2)
3/8	3/8	MH6	12 (305)	SS-MH6-FT6-F12	0.27 (6.9)	1.01 (25.6)
		MM6	36 (914)	SS-MM6-FT6-F36	0.27 (6.9)	0.91 (23.1)

1. All dimensions are for reference only and are subject to change. For dimensions not shown above, please contact FITOK Group or our authorized distributors.
2. Types listed are standard. Other types are available upon request.

## End Connections

### Tube Adapters

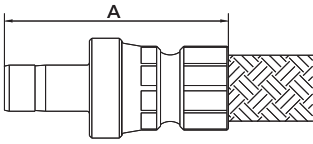

Tube Adapter Size	Nominal Hose Size	End Connection Designator	Dimensions		
			A	Minimum Inside Diameter	Maximum Outside Dimension
<b>in.</b>			<b>in. (mm)</b>		
1/4	1/4	FT4	1.76 (44.7)	0.16 (4.1)	0.81 (20.6)
3/8	3/8	FT6	1.82 (46.2)	0.27 (6.9)	1.01 (25.6)
1/2	1/2	FT8	2.22 (56.4)	0.37 (9.4)	1.23 (31.3)
3/4	3/4	FT12	2.35 (59.7)	0.58 (14.7)	1.53 (38.8)
1	1	FT16	2.69 (68.3)	0.80 (20.3)	1.82 (46.3)
<b>mm</b>	<b>in.</b>	—	<b>mm (in. )</b>		
6	1/4	MT6	44.4 (1.75)	4.1 (0.16)	20.6 (0.81)
10	3/8	MT10	47.0 (1.85)	7.1 (0.28)	25.6 (1.01)
12	1/2	MT12	57.2 (2.25)	8.9 (0.35)	31.3 (1.23)

### Tube Fittings

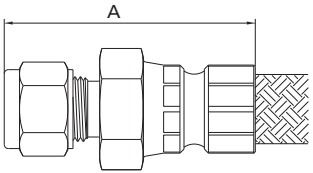

Automatic Weld Style-1 in. and Under

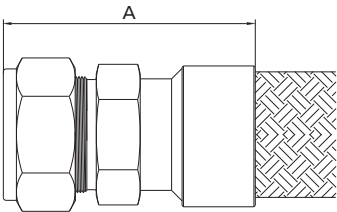

Manual Weld Style-Over 1 in.

Tube Fitting Size	Nominal Hose Size	End Connection Designator	Dimensions		
			A	Minimum Inside Diameter	Maximum Outside Dimension
<b>in.</b>			<b>in. (mm)</b>		
1/4	1/4	FL4	1.94 (49.3)	0.19 (4.8)	0.94 (23.8)
3/8	1/4	FL6	2.00 (50.8)	0.28 (7.1)	0.94 (23.8)
3/8	3/8	FL6	2.02 (51.3)	0.28 (7.1)	1.09 (27.7)
1/2	1/2	FL8	2.24 (56.9)	0.41 (10.4)	1.23 (31.3)
5/8	1/2	FL10	2.27 (57.7)	0.50 (12.7)	1.23 (31.3)
3/4	3/4	FL12	2.35 (59.7)	0.63 (16.0)	1.74 (44.2)
1	1	FL16	2.64 (67.1)	0.88 (22.4)	1.82 (46.3)
1 1/4	1 1/4	FL20	4.04 (103)	1.09 (27.7)	2.23 (58.9)
1 1/2	1 1/2	FL24	4.75 (121)	1.34 (34.0)	2.61 (66.3)
2	2	FL32	5.72 (145)	1.88 (47.8)	3.48 (88.4)
<b>mm</b>	<b>in.</b>	—	<b>mm (in. )</b>		
6	1/4	ML6	62.2 (2.45)	4.8 (0.19)	20.6 (0.81)
8	1/4	ML8	63.2 (2.49)	6.4 (0.25)	20.6 (0.81)
10	3/8	ML10	51.6 (2.03)	7.9 (0.31)	31.3 (1.23)
12	1/2	ML12	56.9 (2.24)	9.7 (0.38)	38.8 (1.53)

### Male FR Metal Gasket Face Seal Fittings Swivel

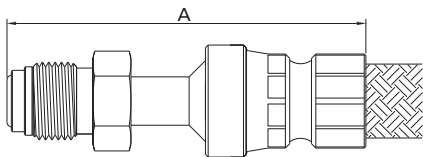

FR Size	Nominal Hose Size	End Connection Designator	Dimensions		
			A	Minimum Inside Diameter	Maximum Outside Dimension
<b>in.</b>			<b>in. (mm)</b>		
1/4	1/4	SFR4	2.60 (66.0)	0.18 (4.6)	0.81 (20.6)
1/2	1/2	SFR8	2.83 (71.9)	0.40 (10.2)	1.23 (31.3)
3/4	3/4	SFR12	4.19 (106)	0.65 (16.5)	1.52 (38.7)
1	1	SFR16	4.80 (122)	0.87 (22.1)	1.53 (38.8)

## End Connections

Female FR Metal Gasket Face Seal Fittings Swivel

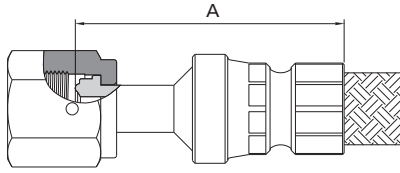

Female FO O-Ring Face Seal Fittings Swivel

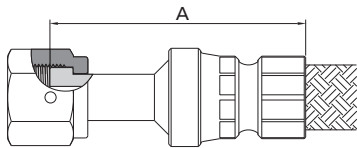

SAE 37° (JIC) Female Swivel

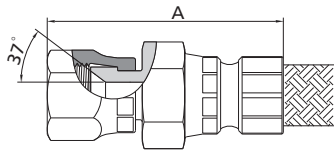

Female Pipe Threads, NPT

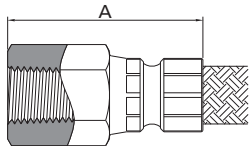

Male Pipe Threads, NPT

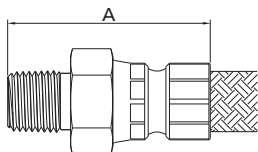

Automatic Weld Style-1 in. and Under

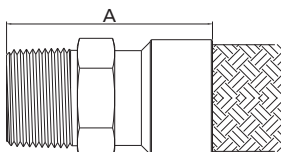

Manual Weld Style-Over 1 in.

FR Size	Nominal Hose Size	End Connection Designator	Dimensions		
			A	Minimum Inside Diameter	Maximum Outside Dimension
in.			in. (mm)		
1/4	1/4	SFFR4	2.00 (50.8)	0.18 (4.6)	0.87 (22.1)
1/2	1/2	SFFR8	2.16 (54.9)	0.40 (10.2)	1.23 (31.3)
3/4	3/4	SFFR12	4.19 (106)	0.65 (16.5)	1.74 (44.2)
1	1	SFFR16	4.80 (122)	0.87 (22.1)	2.03 (51.6)

FO Size	Nominal Hose Size	End Connection Designator	Dimensions		
			A	Minimum Inside Diameter	Maximum Outside Dimension
in.			in. (mm)		
1/4	1/4	SFFO4	2.11 (53.6)	0.18 (4.6)	0.81 (20.6)
1/2	1/2	SFFO8	2.14 (54.4)	0.40 (10.2)	1.23 (31.3)

Swivel Size	Nominal Hose Size	End Connection Designator	Dimensions		
			A	Minimum Inside Diameter	Maximum Outside Dimension
in.			in. (mm)		
1/4	1/4	SAN4	1.87 (47.5)	0.17 (4.3)	0.81 (20.6)
3/8	3/8	SAN6	1.98 (50.3)	0.28 (7.1)	1.01 (25.6)
1/2	1/2	SAN8	2.25 (57.2)	0.42 (10.7)	1.23 (31.3)

NPT Size	Nominal Hose Size	End Connection Designator	Dimensions		
			A	Minimum Inside Diameter	Maximum Outside Dimension
in.			in. (mm)		
1/4	1/4	FNS4	1.81 (46.0)	0.28 (7.1)	0.94 (23.9)
3/8	3/8	FNS6	1.87 (47.5)	0.38 (9.7)	1.09 (27.7)
1/2	1/2	FNS8	2.18 (55.4)	0.47 (11.9)	1.23 (31.3)
3/4	3/4	FNS12	2.21 (56.1)	0.72 (18.3)	1.74 (44.2)

NPT Size	Nominal Hose Size	End Connection Designator	Dimensions		
			A	Minimum Inside Diameter	Maximum Outside Dimension
in.			in. (mm)		
1/4	1/4	NS4	1.80 (45.7)	0.28 (7.1)	0.94 (23.9)
1/4	3/8	NS4	1.81 (46.0)	0.28 (7.1)	1.09 (27.7)
3/8	3/8	NS6	1.81 (46.0)	0.38 (9.7)	1.09 (27.7)
1/2	1/4	NS8	1.99 (50.6)	0.47 (11.9)	1.02 (25.8)
1/2	1/2	NS8	2.15 (54.6)	0.47 (11.9)	1.23 (31.3)
3/4	3/4	NS12	2.22 (56.4)	0.63 (16.0)	1.74 (44.2)
1	1	NS16	2.54 (64.5)	0.88 (22.4)	1.82 (46.3)
1 1/4	1 1/4	NS20	3.06 (77.7)	1.09 (27.7)	2.03 (51.6)
1 1/2	1 1/2	NS24	3.72 (94.5)	1.34 (34.0)	2.47 (62.6)
2	2	NS32	4.19 (106)	1.81 (46.0)	3.19 (81.0)



## Options

### Anti-whip Cable

- 304 stainless steel cable
- Available on hoses without changing the technical data of hoses
- Prevent hoses from whipping around and causing serious injuries in the event of fitting blow-off or hose burst

## Ordering Number Description

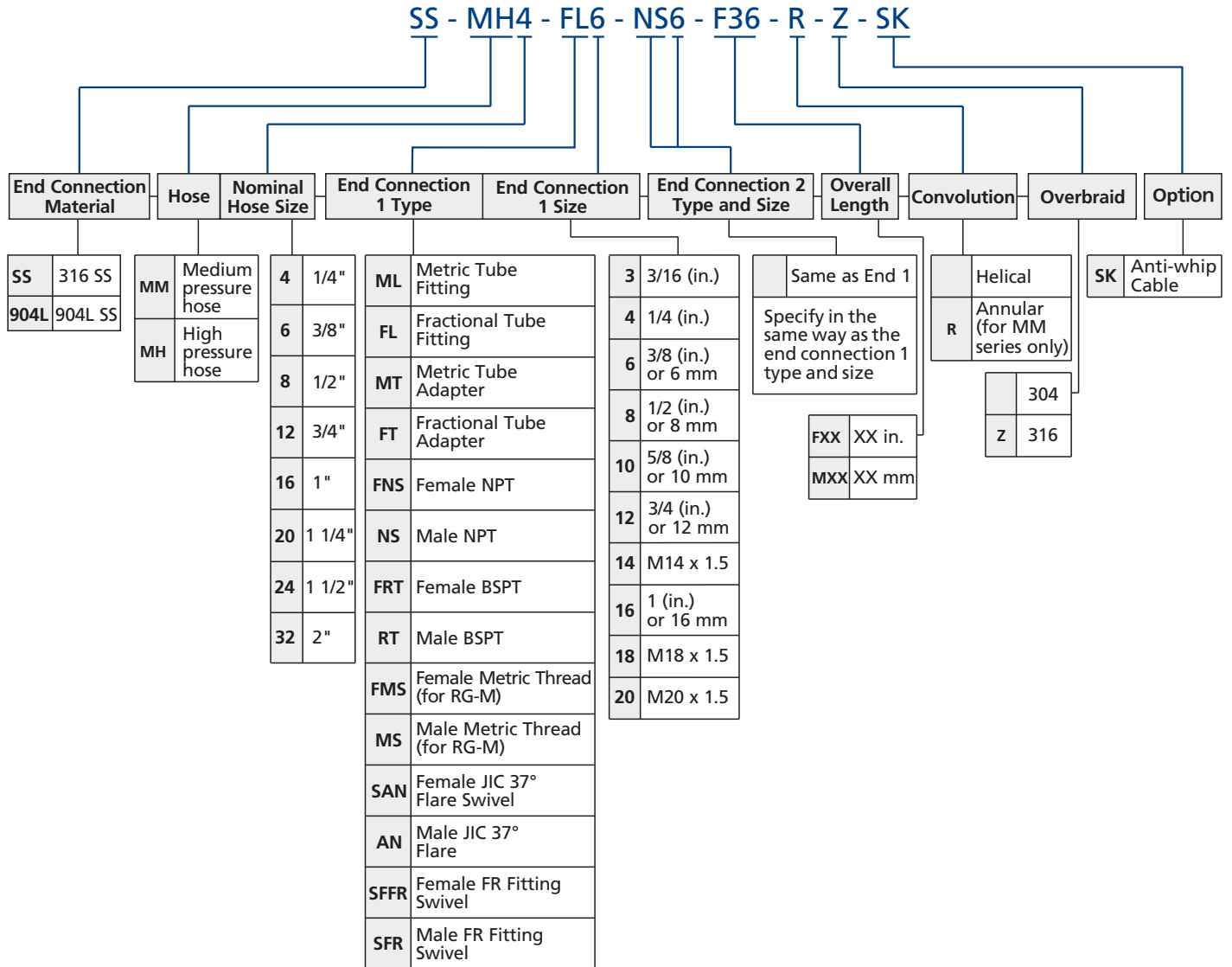

### Example: SS-MH4-FT6-M710

- SS:** End connection material is 316 stainless steel.
- MH4:** MH series, nominal hose size is 1/4".
- FT6:** End connection 1 is 3/8" tube adapter.  
End connection 2 is 3/8" tube adapter.
- M710:** Overall length is 710 mm.

Note: "Ordering Number Description" is a reference to understand the combination rules of FITOK product part number. Not all combinations are available.

Connections are described based on the following rules:

- Metric Tube Fitting - Fractional Tube Fitting - Metric Tube Adapters - Fractional Tube Adapters - NPT Threads - BSPT Threads - BSPP Threads - SAE/MS Parallel Threads - 37° Flare - Others
- Put the sizes from the biggest down to the smallest if they are of the same type.
- Put the female before male if they are of the same type and size.

# PTFE-lined, Stainless Steel Braided Hoses

## PS Series

### Features

- Lightweight construction for easy handling and installation
- Core tube material: smooth virgin PTFE
- Overbraid material: 304 stainless steel
- Working pressure up to: 3000 psig (207 bar)
- Nominal hose size: 1/4" to 1"
- Working temperature: -65°F to 400°F (-53°C to 204°C)
- Standard and custom length available

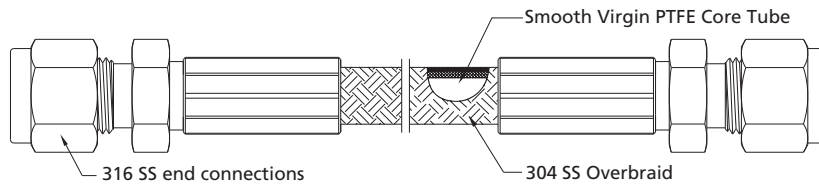

### Hose Technical Data

Nominal Hose Size	Inside Diameter	Min. Inside Bend Radius		Temperature Range	Working Pressure at 70°F (20°C)	Min. Burst Pressure at 70°F (20°C)
		Static	Dynamic			
	in. (mm)	in. (mm)	in. (mm)	°F (°C)	psig (bar)	psig (bar)
1/4 (6.4)	0.19 (4.8)	1.5 (38.1)	2.0 (50.8)	-65 to 400 (-53 to 204)	3000 (206)	12000 (826)
3/8 (9.5)	0.31 (7.9)	3.5 (88.9)	5.0 (127)		2500 (172)	10000 (690)
1/2 (12.7)	0.41 (10.3)	4.5 (114)	6.0 (152)		2000 (137)	8000 (551)
3/4 (19.0)	0.63 (15.9)	6.0 (152)	7.5 (190)		1500 (103)	6000 (413)
1 (25.4)	0.88 (22.2)	9.0 (229)	11.3 (287)		1000 (68)	4000 (275)

### Pressure vs. Temperature

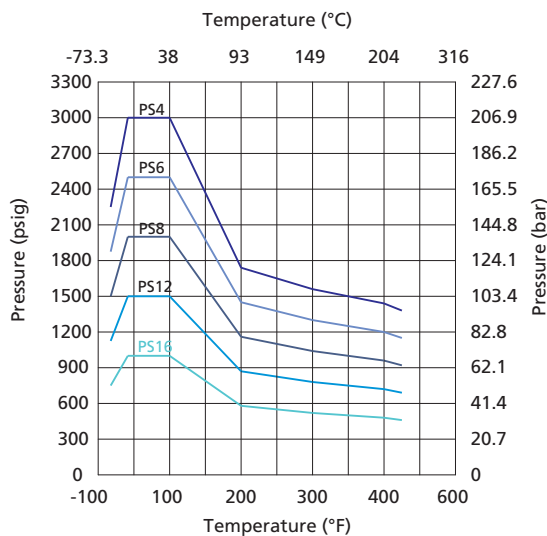

### Testing

Every FITOK PTFE-lined hose assembly is factory tested with pure water at 1.5 times the maximum working pressure.

### Cleaning and Packaging

FITOK PTFE-lined hose components are cleaned in accordance with FITOK *Standard Cleaning and Packaging Process (FC-01)* for general industrial procedures.

Shorter hoses are packed in cartons with suitable protective material, longer hoses are coiled, bagged and boxed or crated.

## PTFE-lined Hose Standard Assemblies

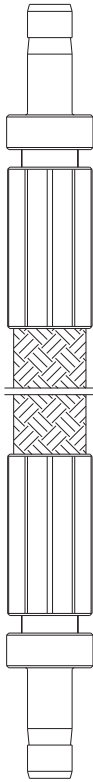

- All dimensions are for reference only and are subject to change. For dimensions not shown above, please contact FITOK Group or our authorized distributors.
- Sizes and types listed are standard. Other sizes and types are available on request.

Nominal Hose Size	Tube Adapter Size		Overall Length	Ordering Number	Minimum Inside Diameter		Maximum Outside Dimension	
	in.	in. (mm)			in. (mm)	in. (mm)		
1/4	1/4	6.0 (153)	SS-PS4-FT4-F6	0.16 (4.1)	0.54 (13.7)			
		12.0 (305)	SS-PS4-FT4-F12					
		18.0 (458)	SS-PS4-FT4-F18					
		24.0 (610)	SS-PS4-FT4-F24					
		36.0 (915)	SS-PS4-FT4-F36					
		48.0 (1220)	SS-PS4-FT4-F48					
		60.0 (1530)	SS-PS4-FT4-F60					
		72.0 (1829)	SS-PS4-FT4-F72					
3/8	3/8	12.0 (305)	SS-PS6-FT6-F12	0.27 (6.9)	0.73 (18.5)			
		18.0 (458)	SS-PS6-FT6-F18					
		24.0 (610)	SS-PS6-FT6-F24					
		36.0 (915)	SS-PS6-FT6-F36					
		48.0 (1220)	SS-PS6-FT6-F48					
		60.0 (1530)	SS-PS6-FT6-F60					
		72.0 (1829)	SS-PS6-FT6-F72					
		96.0 (2439)	SS-PS6-FT6-F96					
1/2	1/2	12.0 (305)	SS-PS8-FT8-F12	0.36 (9.1)	0.86 (21.8)			
		24.0 (610)	SS-PS8-FT8-F24					
		36.0 (915)	SS-PS8-FT8-F36					
		48.0 (1220)	SS-PS8-FT8-F48					
		60.0 (1530)	SS-PS8-FT8-F60					
3/4	3/4	24.0 (610)	SS-PS12-FT12-F24	0.53 (13.5)	1.04 (26.4)			
		36.0 (915)	SS-PS12-FT12-F36					
1	1	36.0 (915)	SS-PS16-FT16-F36	0.80 (20.3)	1.36 (34.5)			
		48.0 (1220)	SS-PS16-FT16-F48					
in.	mm	in. (mm)	—	in. (mm)	in. (mm)			
1/4	6	12.0 (305)	SS-PS4-MT6-F12	0.16 (4.1)	0.54 (13.7)			
		24.0 (610)	SS-PS4-MT6-F24					
		36.0 (915)	SS-PS4-MT6-F36					
1/2	12	24.0 (610)	SS-PS8-MT12-F24	0.33 (8.4)	0.86 (21.8)			
		36.0 (915)	SS-PS8-MT12-F36					

## Options

### Anti-whip Cable

- 304 stainless steel cable
- Available on hoses without changing the technical data of hoses
- Prevent hoses from whipping around and causing serious injuries in the event of fitting blow-off or hose burst

### Spring Guard

- 302 stainless steel material
- Available on hoses without changing the technical data of hoses
- Protect the hose from abrasion, overbending, and kinking

### Fire Jacket

- Braided fiberglass coated with organic, high-temperature-resistant iron oxide red silicone rubber
- Offers excellent flame and fire protection and has good thermal and electrical insulation with resistance to acid & alkali
- Operating temperature from -65 to 500°F (-53 to 260°C) with max. short-term exposure temperature to 3002°F (1650°C).

# Ordering Number Description

SS – PS4 – FL6 – FT6 – M1000 – SPF2

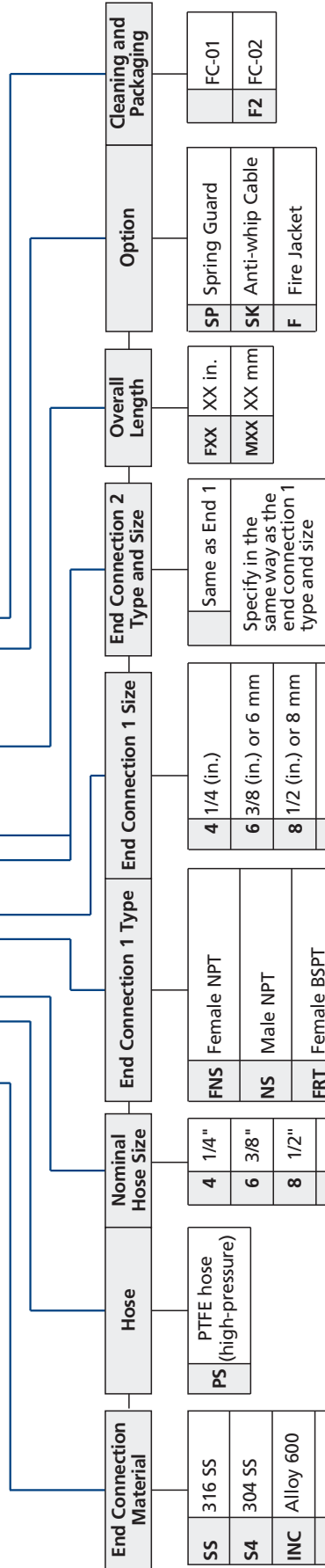

End Connection Material	Hose	Nominal Hose Size	End Connection 1 Type	End Connection 1 Size	End Connection 2 Type and Size	Overall Length	Option	Cleaning and Packaging
SS 316 SS	PS PTFE hose (high-pressure)	4 1/4"	FNS Female NPT	4 1/4 (in.)	Same as End 1 Specify in the same way as the end connection 1 type and size	FXX XX in.	SP Spring Guard SK Anti-whip Cable F Fire Jacket	FC-01 F2 FC-02
S4 304 SS		6 3/8"	NS Male NPT	6 3/8 (in.) or 6 mm		MXX XX mm		
INC Alloy 600		8 1/2"	FRT Female BSPT	8 1/2 (in.) or 8 mm				
A20 Alloy 20		12 3/4"	RT Male BSPT	10 5/8 (in.) or 10 mm				
HC Alloy C-276		16 1"	FMS Female Metric Thread (for RG)	12 3/4 (in.) or 12 mm				
TI Titanium		MS Male Metric Thread (for RG)	14 M14 x 1.5					
904L 904L SS		FL Fractional Tube Fitting	16 1 (in.) or 16 mm					
		ML Metric Tube Fitting	18 M18 x 1.5					
		FT Fractional Tube Adapter	20 M20 x 1.5					
		MT Metric Tube Adapter						
		AN Male JIC 37° Flare						
		SAN Female JIC 37° Flare Swivel						
		SMS Female Metric Thread Swivel (for RG)						
		SNS Male NPT Swivel						
		SRT Metric BSPT Swivel						
		SRG Female BSPP Swivel (for RG)						

Note: "Ordering Number Description" is a reference to understand the combination rules of FITOK product part number. Not all combinations are available.

Connections are described based on the following rules:

1. Metric Tube Fitting - Fractional Tube Fitting - Metric Tube Adapters - Fractional Tube Adapters - NPT Threads - BSPT Threads - BSPP Threads - SAE/MS Parallel Threads - 37° Flare - Others
2. Put the sizes from the biggest down to the smallest if they are of the same type.
3. Put the female before male if they are of the same type and size.

Example: **SS-PS4-SAN4-M500**

**SS**: End connection material is 316 stainless steel.

**PS4**: PS series, hose inside diameter is 3/16".

**SAN4**: End connection 1 is 1/4" female JIC 37° flare swivel.

End connection 2 is 1/4" female JIC 37° flare swivel.

**M500**: Overall length is 500 mm.

# Multipurpose Push-on Hoses

## MP Series

### Features

- Cover: weatherproof, abrasion withstanding and oil-resistant synthetic rubber
- Reinforcement: single-braid high-strength synthetic fiber woven for maximum strength and end connection retention
- Core tube: highly oil-resistant rubber
- Hose colors: blue, black, green, gray, red and yellow
- Working pressure up to: 300 psig (20.7 bar)
- Nominal hose size: 1/4" to 3/4"
- Working temperature: -40°F to 200°F (-40°C to 93°C)
- End connection materials: stainless steel and brass
- End connections reusable
- Custom length available

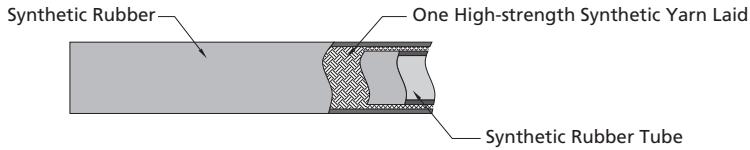

### Hose Technical Data

Nominal Hose Size	Inside Diameter	Min. Inside Bend Radius	Temperature Range	Working Pressure at -40 to 70°F (-40 to 20°C)	Min. Burst Pressure at 70°F (20°C)
	in. (mm)	in. (mm)		°F (°C)	psig (bar)
1/4 (6.4)	0.26 (6.6)	2.50 (63.5)	-40 to 200 (-40 to 93)	300 (20.6)	1200 (82.7)
3/8 (9.5)	0.39 (9.9)	3.00 (76.2)			
1/2 (12.7)	0.50 (12.7)	5.00 (127)			
3/4 (19.0)	0.76 (19.3)	7.00 (178)			

### Pressure vs. Temperature

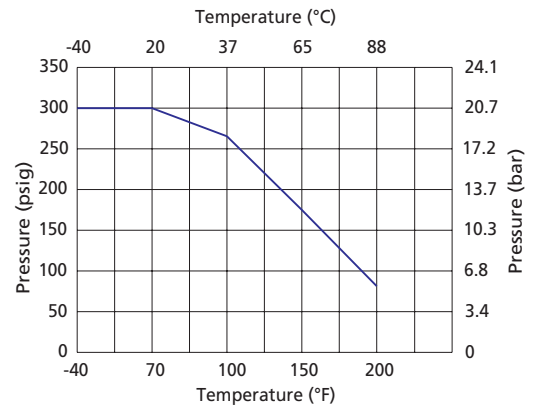

### Testing

Every FITOK multipurpose push-on hose assembly is factory tested with pure water at 1.5 times the maximum working pressure.

### Cleaning and Packaging

FITOK multipurpose push-on hose components are cleaned in accordance with FITOK *Standard Cleaning and Packaging Process (FC-01)* for general industrial procedures.

Shorter hoses are packed in cartons with suitable protective material, longer hoses are coiled, bagged and boxed or crated.

### Caution

- Do not reuse the hose.

## Multipurpose Push-on Hose End Connections

### Tube Fittings

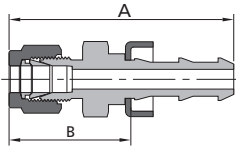

Nominal Hose Size	Tube Fitting Size in.	Basic Ordering Number	Dimensions, in. (mm)			
			A	B	Minimum Inside Diameter	Maximum Outside Dimension
1/4	1/4	-MP4-FL4	1.97 (50.0)	1.21 (30.7)	0.16 (4.1)	0.67 (17.0)
3/8	3/8	-MP6-FL6	2.11 (53.6)	1.24 (31.5)	0.27 (6.9)	0.87 (22.1)
1/2	1/2	-MP8-FL8	2.47 (62.7)	1.42 (36.1)	0.37 (9.5)	1.02 (25.8)

### Tube Adapters

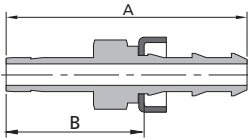

Nominal Hose Size	Tube Adapter Size in.	Basic Ordering Number	Dimensions, in. (mm)			
			A	B	Minimum Inside Diameter	Maximum Outside Dimension
1/4	1/4	-MP4-FT4	1.93 (49.0)	1.17 (29.7)	0.15 (3.8)	0.67 (17.0)
3/8	3/8	-MP6-FT6	2.03 (51.6)	1.16 (29.5)	0.24 (6.1)	0.83 (21.1)
1/2	1/2	-MP8-FT8	2.47 (62.7)	1.42 (36.1)	0.34 (8.7)	0.98 (24.9)
3/4	3/4	-MP12-FT12	3.14 (79.8)	1.48 (37.6)	0.57 (14.5)	1.23 (31.3)
in.	mm	—	mm(in. )			
1/4	6	-MP4-MT6	49.0 (1.93)	29.7 (1.17)	3.8 (0.15)	17.0 (0.67)
1/4	8	-MP4-MT8	48.8 (1.92)	29.5 (1.16)	4.1 (0.16)	17.0 (0.67)
3/8	8	-MP6-MT8	52.1 (2.05)	30.0 (1.18)	5.6 (0.22)	21.1 (0.83)
3/8	10	-MP6-MT10	51.6 (2.03)	29.5 (1.16)	6.9 (0.27)	21.1 (0.83)
1/2	12	-MP8-MT12	62.7 (2.47)	36.1 (1.42)	8.1 (0.32)	24.9 (0.98)
3/4	18	-MP12-MT18	79.8 (3.14)	37.3 (1.47)	8.6 (0.34)	31.3 (1.23)

### Male NPT

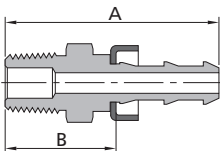

Nominal Hose Size	NPT Size	Basic Ordering Number	Dimensions, in. (mm)			
			A	B	Minimum Inside Diameter	Maximum Outside Dimension
1/4	1/4	-MP4-NS4	1.68 (42.7)	0.92 (23.4)	0.16 (4.1)	0.67 (17.0)
3/8	1/4	-MP6-NS4	1.80 (45.7)	0.93 (23.6)	0.27 (6.9)	0.83 (21.1)
3/8	3/8	-MP6-NS6	1.80 (45.7)	0.93 (23.6)	0.27 (6.9)	0.83 (21.1)
1/2	1/2	-MP8-NS8	2.19 (55.6)	1.14 (29.0)	0.37 (9.5)	1.02 (25.9)
3/4	3/4	-MP12-NS12	2.81 (71.4)	1.14 (29.0)	0.61 (15.6)	1.31 (33.3)

### Male BSPT

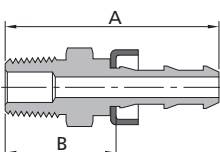

Nominal Hose Size	BSPT Size	Basic Ordering Number	Dimensions, in. (mm)			
			A	B	Minimum Inside Diameter	Maximum Outside Dimension
1/4	1/4	-MP4-RT4	1.68 (42.7)	0.92 (23.4)	0.16 (4.1)	0.67 (17.0)
3/8	1/4	-MP6-RT4	1.80 (45.7)	0.93 (23.6)	0.27 (6.9)	0.83 (21.1)
3/8	3/8	-MP6-RT6	1.80 (45.7)	0.93 (23.6)	0.27 (6.9)	0.83 (21.1)
1/2	1/2	-MP8-RT8	2.19 (55.6)	1.14 (29.0)	0.37 (9.5)	1.02 (25.9)
3/4	3/4	-MP12-RT12	2.81 (71.4)	1.14 (29.0)	0.61 (15.6)	1.31 (33.3)

Unions

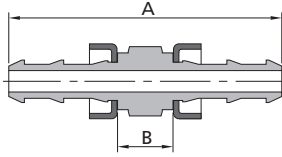

Nominal Hose Size	Basic Ordering Number	Dimensions, in. (mm)			
		A	B	Minimum Inside Diameter	Maximum Outside Dimension
1/4	-MP4-4	2.07 (52.6)	0.43 (11.4)	0.16 (4.1)	0.67 (17.0)
3/8	-MP6-6	2.25 (57.2)	0.40 (12)	0.27 (6.9)	0.83 (21.1)
1/2	-MP8-8	2.61 (69.8)	0.40 (14)	0.37 (9.5)	0.96 (24.5)
3/4	-MP12-12	3.85 (97.8)	0.47 (12.0)	0.61 (15.6)	1.23 (31.3)

## Hose Ordering Number Description

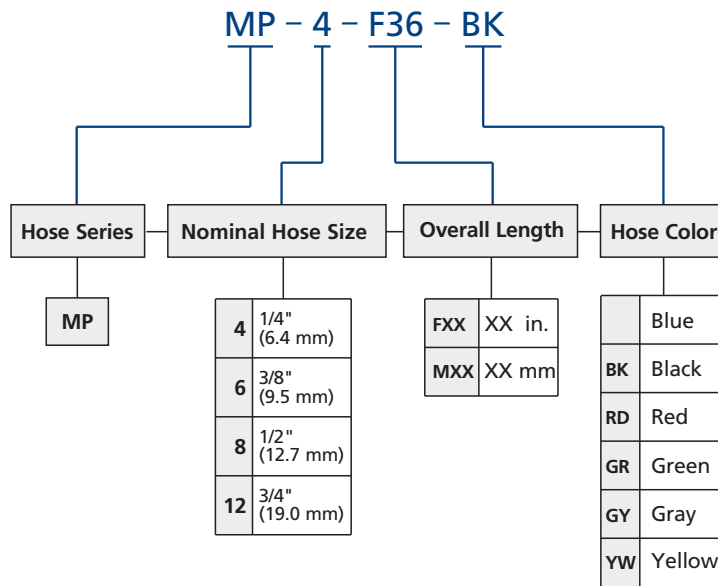

Example: **MP-8-F60-BK**

**MP:** Hose series

**8:** Nominal hose size is 1/2".

**F60:** Overall length is 60".

**BK:** Hose color is black.

Note: "Ordering Number Description" is a reference to understand the combination rules of FITOK product part number. Not all combinations are available.

# Multipurpose Push-On Hose Assemblies



## Ordering Number Description

SS – MP4 – FL4 – FT4 – F36 – BK

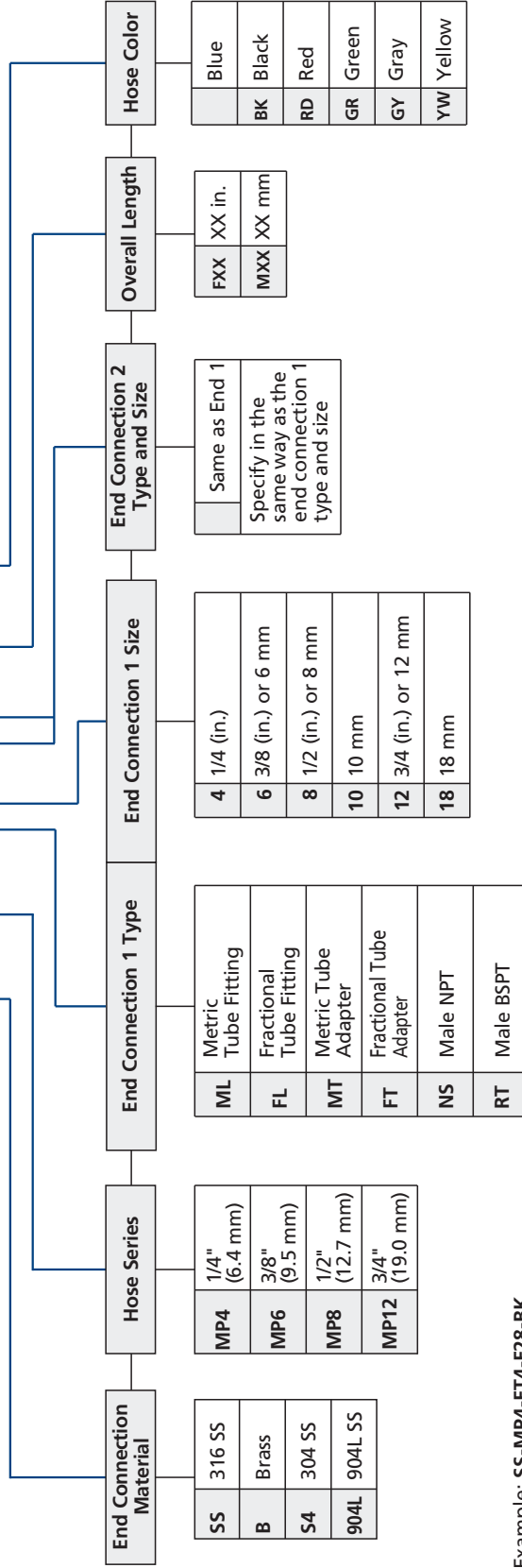

Example: SS-MP4-FT4-F28-BK

SS: End connection material is 316 stainless steel.

MP4: MP series, nominal hose size is 1/4" .

FT4: End connection 1 is 1/4" tube adapter.

F28: End connection 2 is 1/4" tube adapter.

BK : Hose color is black.

Note: "Ordering Number Description" is a reference to understand the combination rules of FITOK product part number. Not all combinations are available.

Connections are described based on the following rules:

1. Metric Tube Fitting - Fractional Tube Fitting - Metric Tube Adapters - Fractional Tube Adapters - NPT Threads - BSPT Threads - BSPP Threads - SAE/MS Parallel Threads - 37° Flare - Others
2. Put the sizes from the biggest down to the smallest if they are of the same type.
3. Put the female before male if they are of the same type and size.



# Thermoplastic Hoses

## TH Series

### Features

- ⦿ Polyurethane cover: resists oil, weather and abrasion
- ⦿ Reinforcement: double-braid high-strength synthetic fiber
- ⦿ Core tube: nylon
- ⦿ Working pressure up to: 5000 psig (345 bar)
- ⦿ Nominal hose size: 3/16" to 1"
- ⦿ Working temperature: -40°F to 200°F (-40°C to 93°C)
- ⦿ End connections: 1/4 to 1 thread, 1/4" to 1" and 6 mm to 22 mm tube fitting
- ⦿ End connection materials: stainless steel, brass and carbon steel
- ⦿ Custom length available

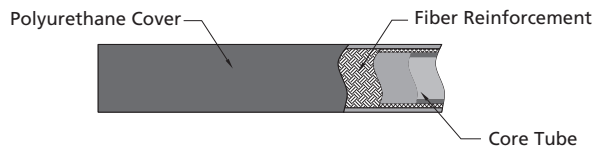

### Technical Data

#### Thermoplastic Hydraulic Hose (SAE 100R7)

Nominal Hose Size	Hose Series	Min. Inside Bend Radius	Inside Diameter	Temperature Range	Working Pressure at 70°F (20°C)	Min. Burst Pressure at 70°F (20°C)	Specification
		in. (mm)	in. (mm)	°F (°C)	psig (bar)	psig (bar)	
3/16 (4.8)	TH3	1.58 (40)	0.19 (4.8)	-40 to 200 (-40 to 93)	3000 (207)	12000 (828)	SAE J517 100R7
1/4 (6.4)	TH4	1.97 (50)	0.25 (6.4)		2750 (189)	11000 (758)	
5/16 (8.0)	TH5	2.36 (60)	0.31 (7.9)		2500 (173)	10000 (690)	
3/8 (9.6)	TH6	2.95 (75)	0.38 (9.8)		2250 (155)	9000 (620)	
1/2 (12.7)	TH8	3.74 (95)	0.50 (12.7)		2000 (137)	8000 (551)	

#### Thermoplastic Hydraulic Hose (SAE 100R8)

Nominal Hose Size	Hose Series	Min. Inside Bend Radius	Inside Diameter	Temperature Range	Working Pressure at 70°F (20°C)	Min. Burst Pressure at 70°F (20°C)	Specification
		in. (mm)	in. (mm)	°F (°C)	psig (bar)	psig (bar)	
3/16 (4.8)	TH3	2.00 (50.8)	0.19 (4.8)	-40 to 200 (-40 to 93)	5000 (344)	20000 (1378)	SAE J517 100R8
1/4 (6.4)	TH4	2.00 (50.8)	0.25 (6.4)		5000 (344)	20000 (1378)	
3/8 (9.6)	TH6	2.50 (63.5)	0.38 (9.8)		4000 (275)	16000 (1102)	
1/2 (12.7)	TH8	4.00 (102)	0.50 (12.7)		3500 (241)	14000 (964)	
3/4 (19.0)	TH12	6.50 (165)	0.75 (19.0)		2250 (155)	9000 (620)	
1 (25.4)	TH16	10.0 (254)	1.00 (25.4)		2000 (137)	8000 (551)	

### Testing

Every FITOK thermoplastic hose assembly is factory tested with pure water at 1.5 times the maximum working pressure.

### Cleaning and Packaging

FITOK thermoplastic hose components are cleaned in accordance with FITOK *Standard Cleaning and Packaging Process (FC-01)* for general industrial procedures.

Shorter hoses are packed in cartons with suitable protective material, longer hoses are coiled, bagged and boxed or crated.

## Options

### Anti-whip Cable

- ⦿ 304 stainless steel cable
- ⦿ Available on hoses without changing the technical data of hoses
- ⦿ Prevent hoses from whipping around and causing serious injuries in the event of fitting blow-off or hose burst

## Thermoplastic Hose Assemblies



## Ordering Number Description

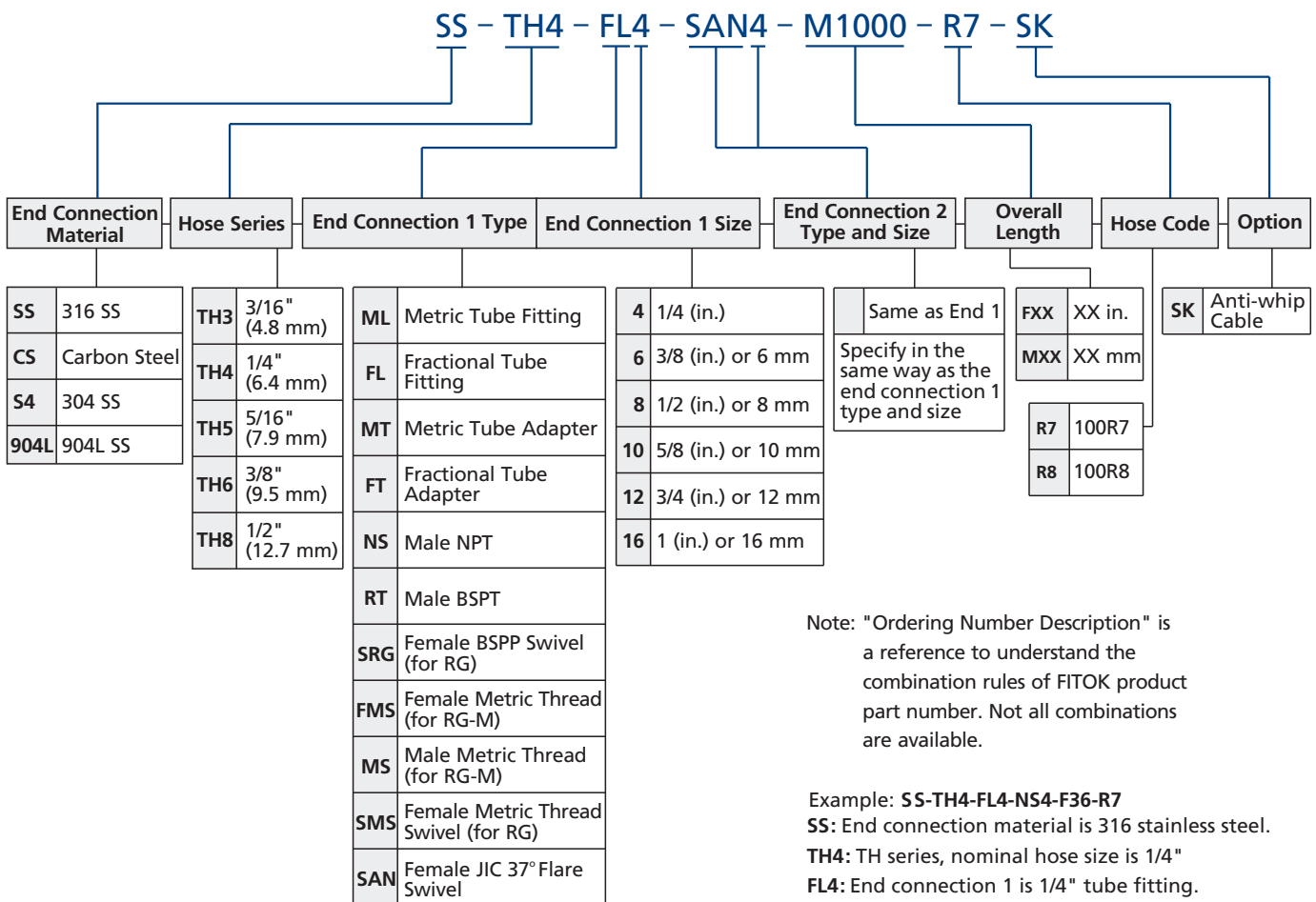

Connections are described based on the following rules:

1. Metric Tube Fitting - Fractional Tube Fitting - Metric Tube Adapters - Fractional Tube Adapters - NPT Threads - BSPT Threads - BSPP Threads - SAE/MS Parallel Threads - 37° Flare - Others
2. Put the sizes from the biggest down to the smallest if they are of the same type.
3. Put the female before male if they are of the same type and size.

# Hose Connectors and Sleeves

## HC Series

### Features

- ⦿ Used to connect soft plastic or rubber tubing
- ⦿ Working pressures and working temperatures are wider than those of the connected hoses
- ⦿ Stainless steel or brass is available
- ⦿ Shank design holds tubing inside diameter securely
- ⦿ Hose connectors are reusable



### Hose Connectors

#### Tube Fittings

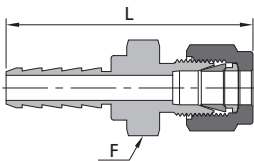

Hose ID	Tube Size	Basic Ordering Number	Dimensions		
			Minimum Inside Diameter	F	L
in.	in.		in. (mm)	in.	in. (mm)
1/8	1/8	-HC-F2-FL2	0.08 (2.0)	7/16	1.42 (36.1)
1/4	1/8	-HC-F4-FL2	0.09 (2.3)	7/16	1.81 (46.0)
	1/4	-HC-F4-FL4	0.19 (4.8)	9/16	1.92 (48.8)
3/8	1/4	-HC-F6-FL4	0.19 (4.8)	9/16	1.99 (50.6)
	3/8	-HC-F6-FL6	0.28 (7.1)	3/4	2.06 (52.3)
1/2	1/2	-HC-F8-FL8	0.38 (9.7)	7/8	2.24 (56.9)
mm	mm	—	mm (in. )	mm	mm (in. )
6	6	-HC-M6-ML6	4.8 (0.19)	14	49.5 (1.95)
8	8	-HC-M8-ML8	6.4 (0.25)	16	49.8 (1.96)
	10	-HC-M8-ML10	6.4 (0.25)	18	51.6 (2.03)
10	10	-HC-M10-ML10	7.9 (0.31)	19	52.3 (2.06)
12	12	-HC-M12-ML12	9.7 (0.38)	22	57.4 (2.26)

#### Tube Adapters

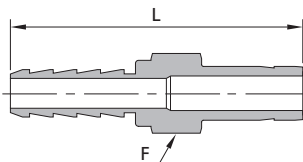

Hose ID	Tube Size	Basic Ordering Number	Dimensions		
			Minimum Inside Diameter	F	L
in.	in.		in. (mm)	in.	in. (mm)
1/8	1/8	-HC-F2-FT2	0.08 (2.0)	5/16	1.37 (34.8)
	1/4	-HC-F2-FT4	0.09 (2.3)	3/8	1.47 (37.3)
1/4	1/4	-HC-F4-FT4	0.19 (4.8)	7/16	1.86 (47.2)
	3/8	-HC-F4-FT6	0.19 (4.8)	7/16	1.92 (48.8)
5/16	1/4	-HC-F5-FT4	0.19 (4.8)	7/16	1.94 (49.3)
3/8	1/4	-HC-F6-FT4	0.19 (4.8)	9/16	1.94 (49.3)
	3/8	-HC-F6-FT6	0.28 (7.1)	9/16	2.00 (50.8)
	1/2	-HC-F6-FT8	0.30 (7.6)	5/8	2.26 (57.4)
1/2	3/8	-HC-F8-FT6	0.28 (7.1)	11/16	2.07 (52.6)
	1/2	-HC-F8-FT8	0.38 (9.7)	11/16	2.33 (59.2)
3/4	3/4	-HC-F12-FT12	0.63 (16.0)	13/16	2.50 (63.5)
1	1	-HC-F16-FT16	0.80 (20.3)	1 3/8	3.03 (77.0)

Male NPT

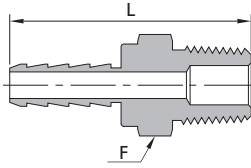

Hose ID	NPT Size	Basic Ordering Number	Dimensions		
			Minimum Inside Diameter	F	L
in.			in. (mm)	in.	in. (mm)
1/8	1/8	-HC-F2-NS2	0.08 (2.0)	7/16	1.08 (27.4)
	1/4	-HC-F2-NS4	0.08 (2.0)	9/16	1.26 (32.0)
3/16	1/8	-HC-F3-NS2	0.13 (3.3)	7/16	1.27 (32.2)
	1/4	-HC-F3-NS4	0.13 (3.3)	9/16	1.45 (36.8)
1/4	1/8	-HC-F4-NS2	0.19 (4.8)	7/16	1.47 (37.3)
	1/4	-HC-F4-NS4	0.19 (4.8)	9/16	1.65 (41.9)
	3/8	-HC-F4-NS6	0.19 (4.8)	11/16	1.66 (42.2)
	1/2	-HC-F4-NS8	0.19 (4.8)	7/8	1.85 (47.0)
5/16	1/8	-HC-F5-NS2	0.19 (4.8)	7/16	1.55 (39.4)
	1/4	-HC-F5-NS4	0.19 (4.8)	9/16	1.73 (43.9)
	3/8	-HC-F5-NS6	0.19 (4.8)	11/16	1.74 (44.2)
	1/2	-HC-F5-NS8	0.19 (4.8)	7/8	1.96 (49.8)
3/8	1/4	-HC-F6-NS4	0.30 (7.6)	9/16	1.73 (43.9)
	3/8	-HC-F6-NS6	0.30 (7.6)	11/16	1.74 (44.2)
	1/2	-HC-F6-NS8	0.30 (7.6)	7/8	1.96 (49.8)
1/2	1/4	-HC-F8-NS4	0.30 (7.6)	11/16	1.80 (45.7)
	3/8	-HC-F8-NS6	0.38 (9.7)	11/16	1.81 (46.0)
	1/2	-HC-F8-NS8	0.38 (9.7)	7/8	2.03 (51.6)
5/8	3/8	-HC-F10-NS6	0.38 (9.7)	1 1/16	1.88 (47.8)
	1/2	-HC-F10-NS8	0.47 (11.9)	1 1/16	2.07 (52.6)
	3/4	-HC-F10-NS12	0.50 (12.7)	1 1/16	2.07 (52.6)
3/4	1/2	-HC-F12-NS8	0.47 (11.9)	1 1/16	2.14 (54.4)
	3/4	-HC-F12-NS12	0.63 (16.0)	1 1/16	2.14 (54.4)
	1	-HC-F12-NS16	0.63 (16.0)	1 3/8	2.43 (61.7)
1	3/4	-HC-F16-NS12	0.63 (16.0)	1 3/8	2.38 (60.5)
	1	-HC-F16-NS16	0.88 (22.4)	1 3/8	2.57 (65.3)

Female NPT

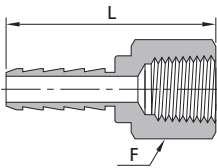

Hose ID	NPT Size	Basic Ordering Number	Dimensions		
			Minimum Inside Diameter	F	L
in.			in. (mm)	in.	in. (mm)
1/8	1/8	-HC-F2-FNS2	0.08 (2.0)	9/16	1.11 (28.2)
	1/4	-HC-F2-FNS4	0.08 (2.0)	3/4	1.26 (32.0)
3/16	1/8	-HC-F3-FNS2	0.13 (3.3)	9/16	1.29 (32.8)
	1/4	-HC-F3-FNS4	0.13 (3.3)	3/4	1.44 (36.6)
1/4	1/8	-HC-F4-FNS2	0.19 (4.8)	9/16	1.47 (37.3)
	1/4	-HC-F4-FNS4	0.19 (4.8)	3/4	1.64 (41.7)
	3/8	-HC-F4-FNS6	0.19 (4.8)	7/8	1.71 (43.4)
5/16	1/4	-HC-F5-FNS4	0.19 (4.8)	3/4	1.73 (43.9)
	3/8	-HC-F5-FNS6	0.19 (4.8)	7/8	1.82 (46.2)
3/8	1/4	-HC-F6-FNS4	0.30 (7.6)	3/4	1.69 (42.9)
	3/8	-HC-F6-FNS6	0.30 (7.6)	7/8	1.78 (45.2)
	1/2	-HC-F6-FNS8	0.30 (7.6)	1 1/16	2.03 (51.6)
1/2	1/2	-HC-F8-FNS8	0.38 (9.7)	1 1/16	2.13 (54.1)

Hoses Quick-Connects

Male BSPT

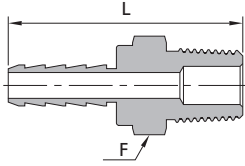

Hose ID	BSPT Size	Basic Ordering Number	Dimensions		
			Minimum Inside Diameter	F	L
in.			in. (mm)	in.	in. (mm)
1/8	1/8	-HC-F2-RT2	0.08 (2.0)	7/16	1.28 (32.5)
	1/4	-HC-F2-RT4	0.08 (2.0)	9/16	1.40 (35.5)
3/16	1/8	-HC-F3-RT2	0.13 (3.3)	7/16	1.40 (35.5)
	1/4	-HC-F3-RT4	0.13 (3.3)	9/16	1.58 (40.1)
1/4	1/8	-HC-F4-RT2	0.19 (4.8)	7/16	1.47 (37.3)
	1/4	-HC-F4-RT4	0.19 (4.8)	9/16	1.65 (41.9)
	3/8	-HC-F4-RT6	0.19 (4.8)	11/16	1.66 (42.2)
	1/2	-HC-F4-RT8	0.19 (4.8)	7/8	1.90 (48.3)
5/16	1/8	-HC-F5-RT2	0.19 (4.8)	7/16	1.67 (42.4)
	1/4	-HC-F5-RT4	0.19 (4.8)	9/16	1.86 (47.2)
	3/8	-HC-F5-RT6	0.19 (4.8)	11/16	1.87 (47.5)
	1/2	-HC-F5-RT8	0.19 (4.8)	7/8	2.10 (53.3)
3/8	1/4	-HC-F6-RT4	0.30 (7.6)	9/16	1.73 (43.9)
	3/8	-HC-F6-RT6	0.30 (7.6)	11/16	1.74 (44.2)
	1/2	-HC-F6-RT8	0.30 (7.6)	7/8	1.96 (49.8)
1/2	1/4	-HC-F8-RT4	0.30 (7.6)	11/16	1.80 (45.7)
	3/8	-HC-F8-RT6	0.38 (9.7)	11/16	1.81 (46.0)
	1/2	-HC-F8-RT8	0.38 (9.7)	7/8	2.03 (51.6)
5/8	3/8	-HC-F10-RT6	0.38 (9.7)	1 1/16	1.88 (47.8)
	1/2	-HC-F10-RT8	0.47 (11.9)	1 1/16	2.07 (52.6)
	3/4	-HC-F10-RT12	0.50 (12.7)	1 1/16	2.07 (52.6)
3/4	1/2	-HC-F12-RT8	0.47 (11.9)	1 1/16	2.14 (54.4)
	3/4	-HC-F12-RT12	0.63 (16.0)	1 1/16	2.14 (54.4)
	1	-HC-F12-RT16	0.63 (16.0)	1 3/8	2.43 (61.7)
1	3/4	-HC-F16-RT12	0.63 (16.0)	1 3/8	2.38 (60.5)
	1	-HC-F16-RT16	0.88 (22.4)	1 3/8	2.57 (65.3)

Female BSPT

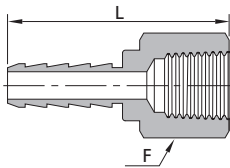

Hose ID	BSPT Size	Basic Ordering Number	Dimensions		
			Minimum Inside Diameter	F	L
in.			in. (mm)	in.	in. (mm)
1/8	1/8	-HC-F2-FRT2	0.08 (2.0)	9/16	1.11 (28.2)
	1/4	-HC-F2-FRT4	0.08 (2.0)	3/4	1.26 (32.0)
3/16	1/8	-HC-F3-FRT2	0.13 (3.3)	9/16	1.29 (32.8)
	1/4	-HC-F3-FRT4	0.13 (3.3)	3/4	1.44 (36.6)
1/4	1/8	-HC-F4-FRT2	0.19 (4.8)	9/16	1.47 (37.3)
	1/4	-HC-F4-FRT4	0.19 (4.8)	3/4	1.64 (41.7)
	3/8	-HC-F4-FRT6	0.19 (4.8)	7/8	1.71 (43.4)
5/16	1/4	-HC-F5-FRT4	0.19 (4.8)	3/4	1.73 (43.9)
	3/8	-HC-F5-FRT6	0.19 (4.8)	7/8	1.82 (46.2)
3/8	1/4	-HC-F6-FRT4	0.30 (7.6)	3/4	1.69 (42.9)
	3/8	-HC-F6-FRT6	0.30 (7.6)	7/8	1.78 (45.2)
	1/2	-HC-F6-FRT8	0.30 (7.6)	1 1/16	2.03 (51.6)
1/2	1/2	-HC-F8-FRT8	0.38 (9.7)	1 1/16	2.13 (54.1)

**Metric Thread**

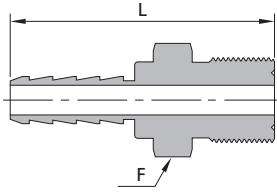

Hose I.D.	Thread Size	Basic Ordering Number	Dimensions		
			Minimum Inside Diameter	F	L
mm	in.		in. (mm)	mm	in. (mm)
6	M10 x 1	-HC-M6-MS10	0.18 (4.6)	12	1.54 (39.6)
	M12 x 1.5	-HC-M6-MS12	0.18 (4.6)	14	1.59 (40.4)
	M14 x 1.5	-HC-M6-MS14	0.18 (4.6)	15	1.66 (42.2)
8	M14 x 1.5	-HC-M8-MS14	0.19 (4.8)	15	1.74 (44.2)
	M16 x 1.5	-HC-M8-MS16	0.19 (4.8)	18	1.82 (46.2)
10	M16 x 1.5	-HC-M10-MS16	0.31 (7.9)	18	1.82 (46.2)
	M18 x 1.5	-HC-M10-MS18	0.31 (7.9)	19	1.86 (47.2)
12	M20 x 1.5	-HC-M12-MS20	0.35 (8.9)	22	1.98 (50.3)
	M22 x 1.5	-HC-M12-MS22	0.35 (8.9)	24	2.08 (52.8)

**Hose Connector Sleeves**

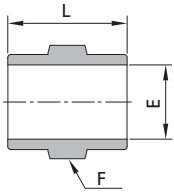

Hose I.D.	Hose O.D.	Ordering Number	Dimensions, in. (mm)		
			E	F	L
in.	in.				
1/8	1/4	AL-HC-F2-F4	0.26 (6.6)	3/8	0.40 (10.2)
1/4	3/8	AL-HC-F4-F6	0.41 (10.4)	9/16	0.79 (20.1)
1/4	7/16	AL-HC-F4-F7	0.46 (11.7)	5/8	0.79 (20.1)
1/4	1/2	AL-HC-F4-F8	0.52 (13.2)	11/16	0.79 (20.1)
5/16	7/16	AL-HC-F5-F7	0.48 (12.2)	5/8	0.87 (22.1)
3/8	1/2	AL-HC-F6-F8	0.55 (14.0)	11/16	0.87 (22.1)
3/8	9/16	AL-HC-F6-F9	0.61 (15.5)	3/4	0.87 (22.1)
7/16	5/8	AL-HC-F7-F10	0.69 (17.5)	13/16	0.94 (23.9)
1/2	11/16	AL-HC-F8-F11	0.76 (19.3)	7/8	0.94 (23.9)
3/4	1	AL-HC-F12-F16	1.10 (27.9)	1 1/4	1.07 (27.2)

- ⦿ Material: Aluminum
- ⦿ Reusable

**Hose Clamps**

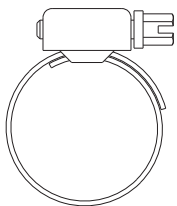

Min. Hose O.D.	Max. Hose O.D.	Ordering Number
mm	mm	
8	12	CP8-12
10	16	CP10-16
12	20	CP12-20
16	25	CP16-25
20	32	CP20-32
25	40	CP25-40

- ⦿ Material: 304 SS
- ⦿ Reusable

1. Sizes and types listed are standard. Other sizes and types are available upon request.
2. All dimensions are for reference only and are subject to change. For dimensions not shown above, please contact FITOK Group or our authorized distributors.

## Ordering Number Description

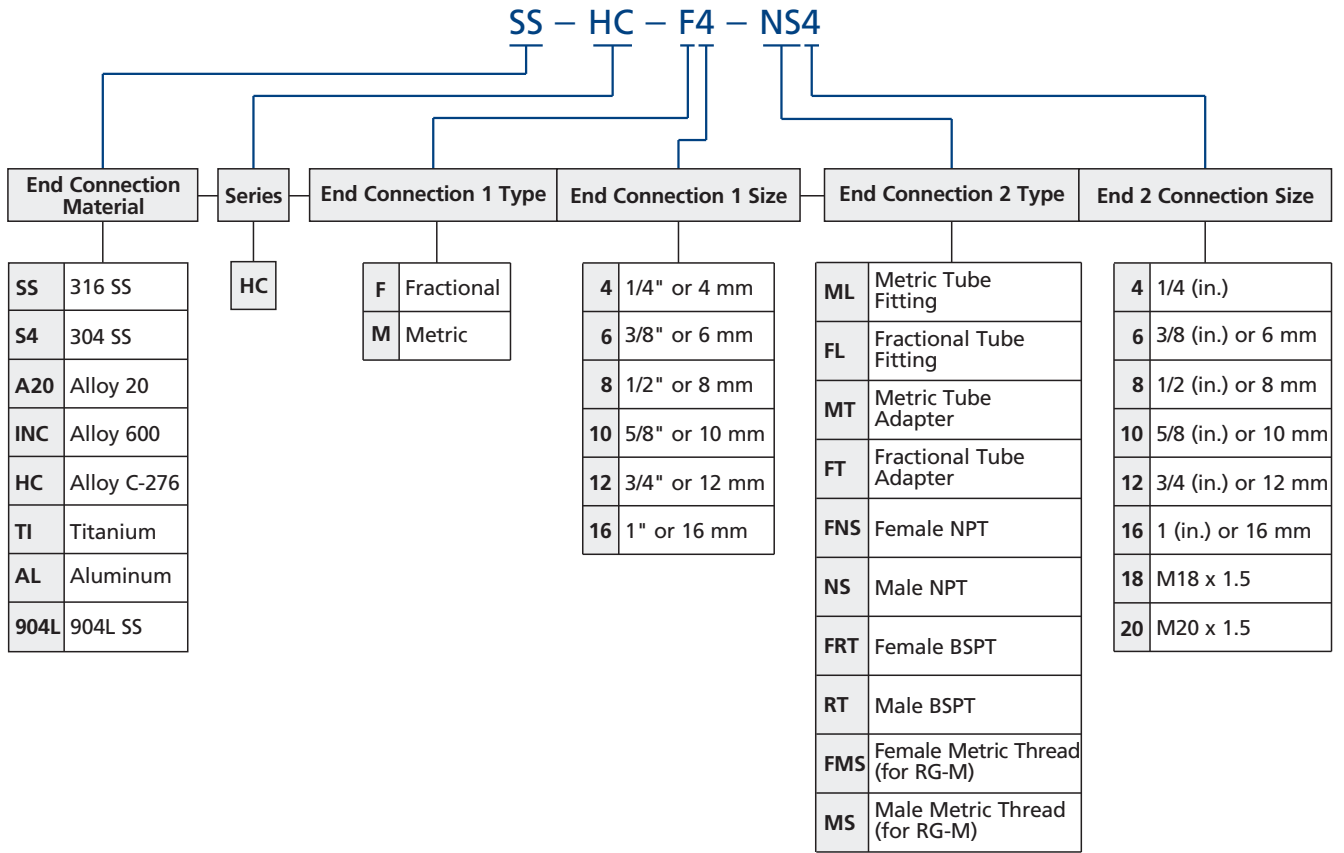

**Example: SS-HC-F4-FT6**

**SS:** End connection material is 316 stainless steel.

**HC:** HC series.

**F4:** Hose ID is 1/4" .

**FT6:** 3/8" tube adapter.

Note: "Ordering Number Description" is a reference to understand the combination rules of FITOK product part number. Not all combinations are available.

[info@fitokgroup.com](mailto:info@fitokgroup.com)  
[www.fitokgroup.com](http://www.fitokgroup.com)

FK-IC-GT-02-EN-220607